

OPTION 1

OPTION 2

OPTION 3

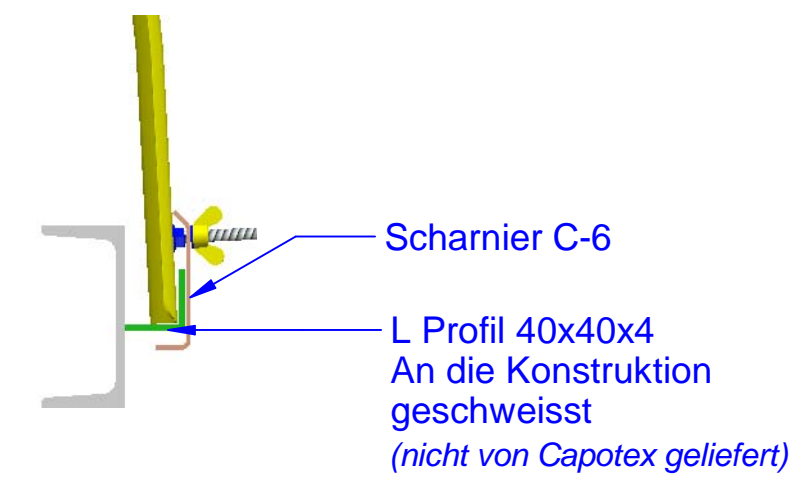
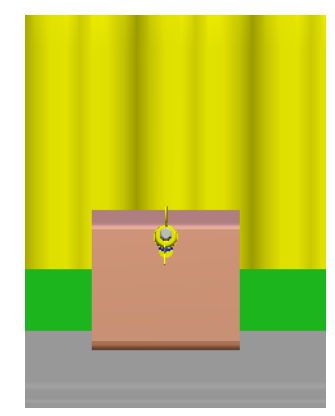
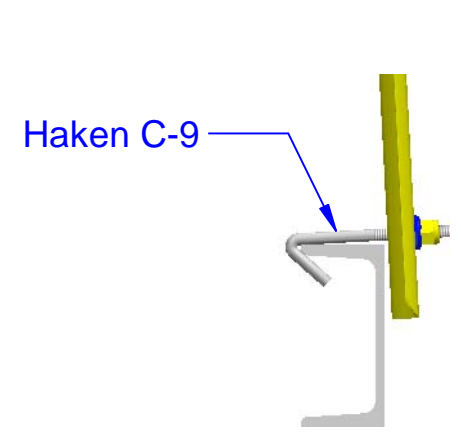
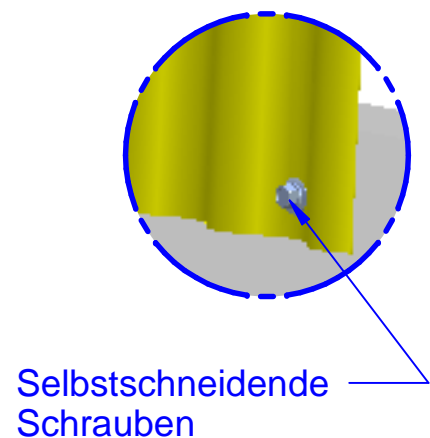

NOT SPECIFIED TOLERANCE			
DIMENSIONS		ANGLES	
( )	: ±2.00	0°	: ±02' 00"
X.	: ±0.50	0° 0'	: ±00' 30"
X.0	: ±0.25	0° 0' 0"	: ±00' 03"
X.00	: ±0.08		
X.000	: ±0.02		

CAD DRAWING. HANDLING ON CAD SYSTEM ONLY

THIS DRAWING IS OWNED BY **CAPOTEX**.  
COPY OR REPRODUCTION IS FORBIDDEN  
WITHOUT PREVIOUS NOTICE

SCALE	DESIGNED	DRAWN	CHECKED	SHEET 5 OF 8	FORMAT
-				NAME	EUR
	DATE			SIGNATURE	A3
		M. MATILLA			
NAME	ABDECKUNG MODELL DAKAR CLASSIC				DRAWING NUMBER
					CAD FILE
					CAPOTAJE DAKAR REV.C.dft

Option mit ergonomischen Haken auf beiden Seiten

OPTION 4

MIT PLETINE

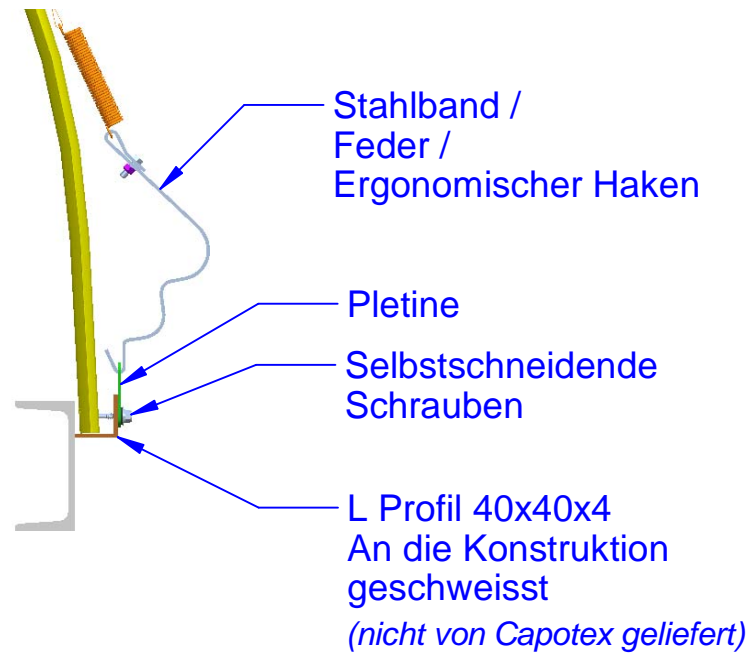

OPTION 4

OHNE PLETINE

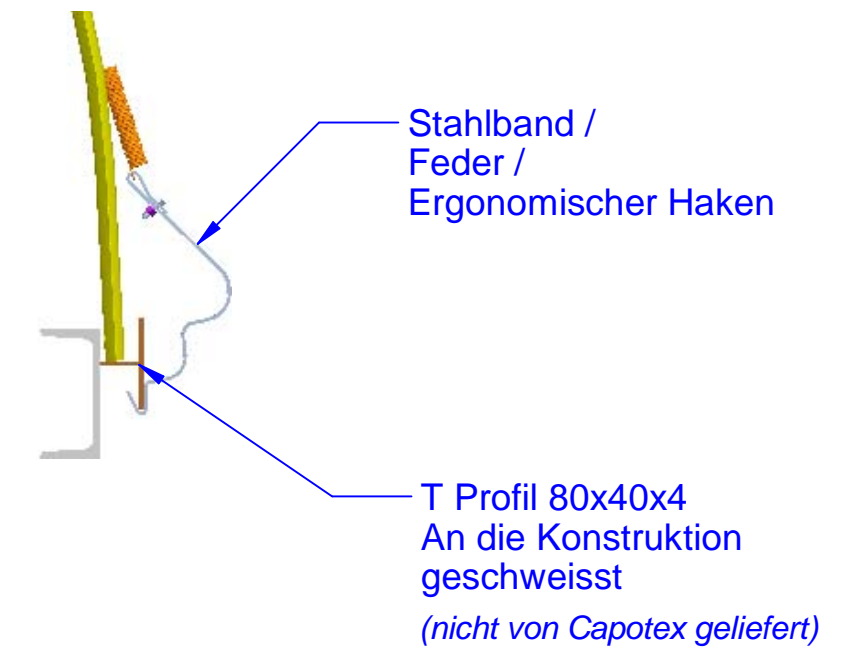
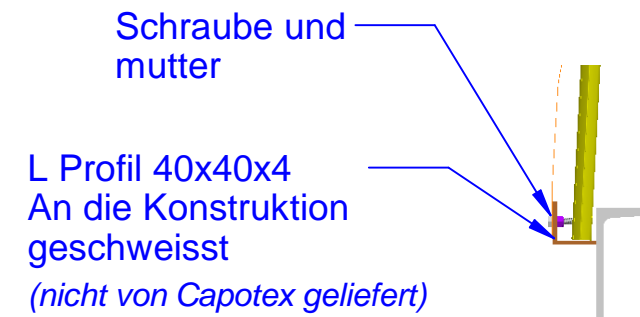

OPTION 5

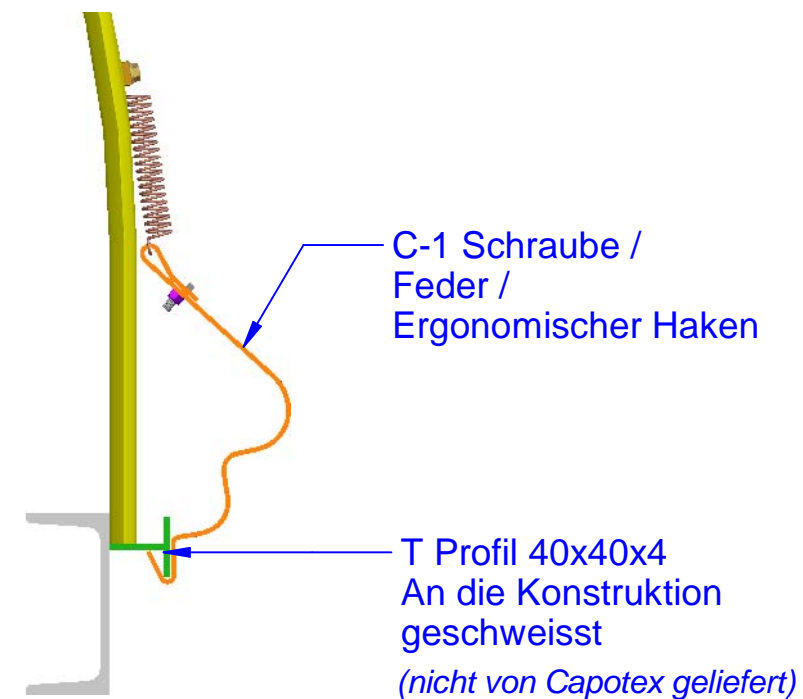
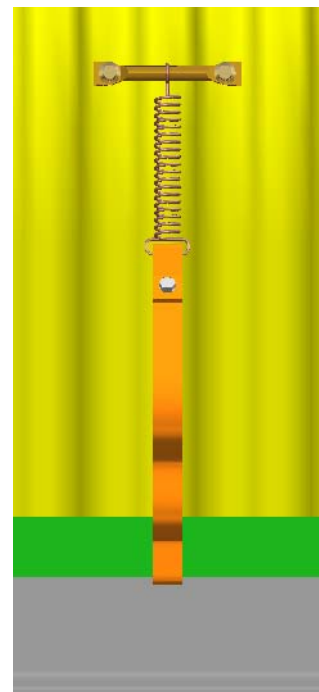

NOT SPECIFIED TOLERANCE

DIMENSIONS		ANGLES	
( )	: ±2.00	0°	: ±02' 00"
X.	: ±0.50	0° 0'	: ±00' 30"
X.0	: ±0.25	0° 0' 0"	: ±00' 03"
X.00	: ±0.08		
X.000	: ±0.02		

CAD DRAWING. HANDLING ON CAD SYSTEM ONLY

THIS DRAWING IS OWNED BY **CAPOTEX**.  
COPY OR REPRODUCTION IS FORBIDDEN  
WITHOUT PREVIOUS NOTICE

SCALE	DESIGNED	DRAWN	CHECKED	SHEET 6 OF 8	FORMAT
-	M. MATILLA			EUR	A3

NAME  
**ABDECKUNG  
MODELL DAKAR CLASSIC**

DRAWING NUMBER
CAD FILE
CAPOTAJE DAKAR REV.C.dft