

OPTION 1

OPTION 2

OPTION 3

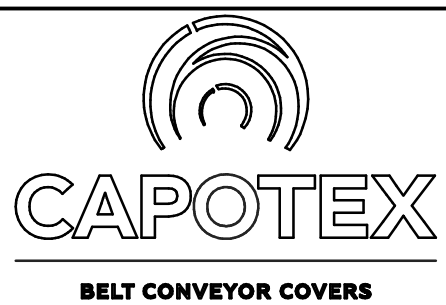
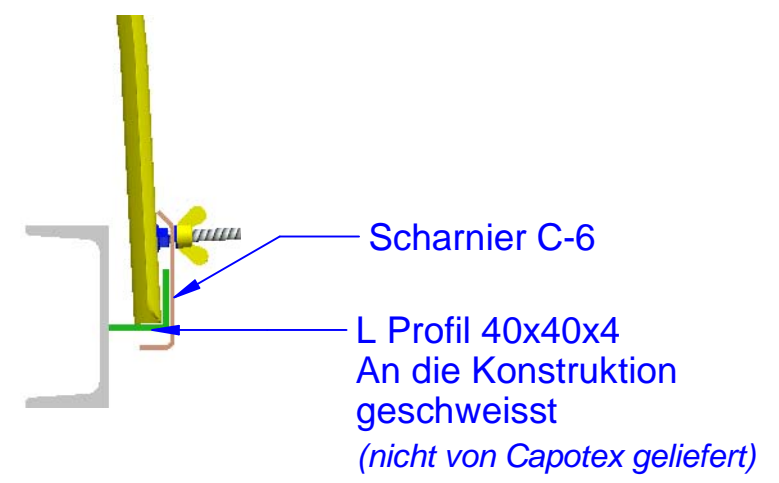
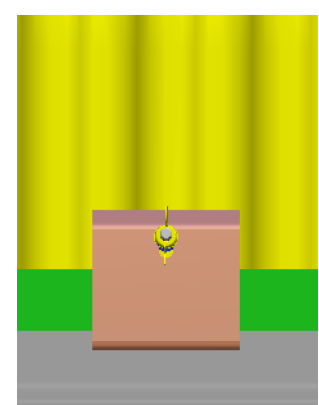
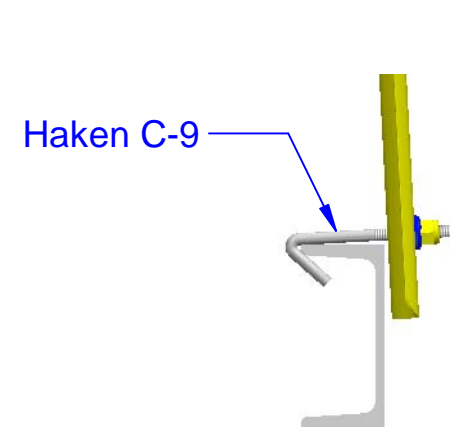
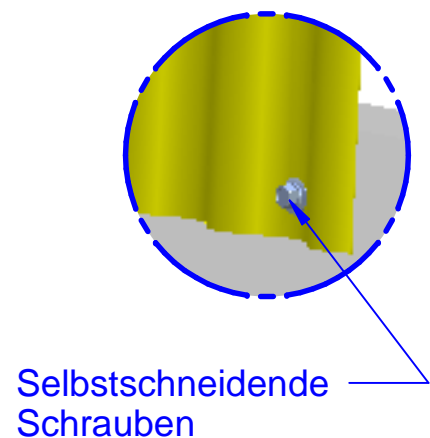

NOT SPECIFIED TOLERANCE			
DIMENSIONS		ANGLES	
()	: ±2.00	0°	: ±02' 00"
X.	: ±0.50	0° 0'	: ±00' 30"
X.0	: ±0.25	0° 0' 0"	: ±00' 03"
X.00	: ±0.08		
X.000	: ±0.02		

CAD DRAWING. HANDLING ON CAD SYSTEM ONLY

THIS DRAWING IS OWNED BY **CAPOTEX**.
COPY OR REPRODUCTION IS FORBIDDEN
WITHOUT PREVIOUS NOTICE

SCALE	DESIGNED	DRAWN	CHECKED	SHEET 5 OF 8	FORMAT
1:1				NAME	EUR
NAME	SIGNATURE			M. MATILLA	A3
ABDECKUNG MODELL DAKAR PLUS					DRAWING NUMBER
					CAD FILE
					CAPOTAJE DAKAR PLUS REV.C.dft

Option mit ergonomischen Haken auf beiden Seiten

OPTION 4

MIT PLETINE

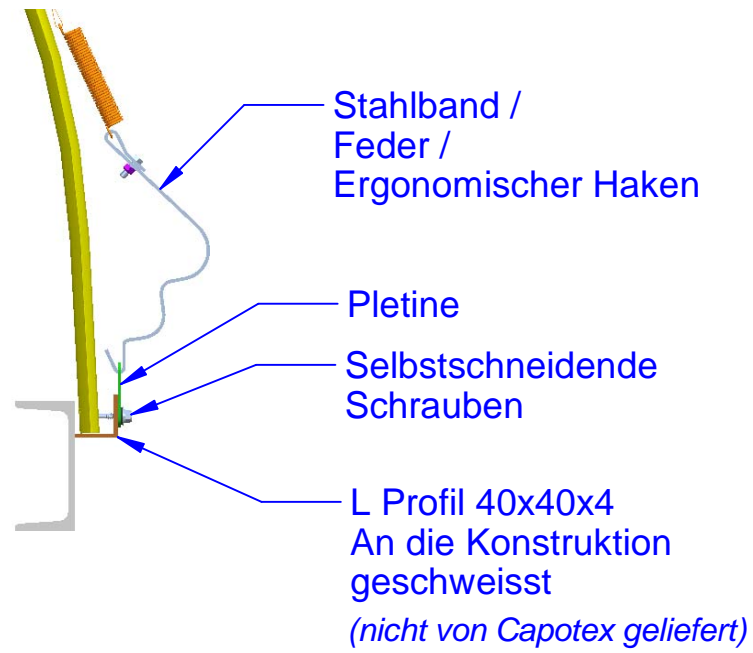

OPTION 4

OHNE PLETINE

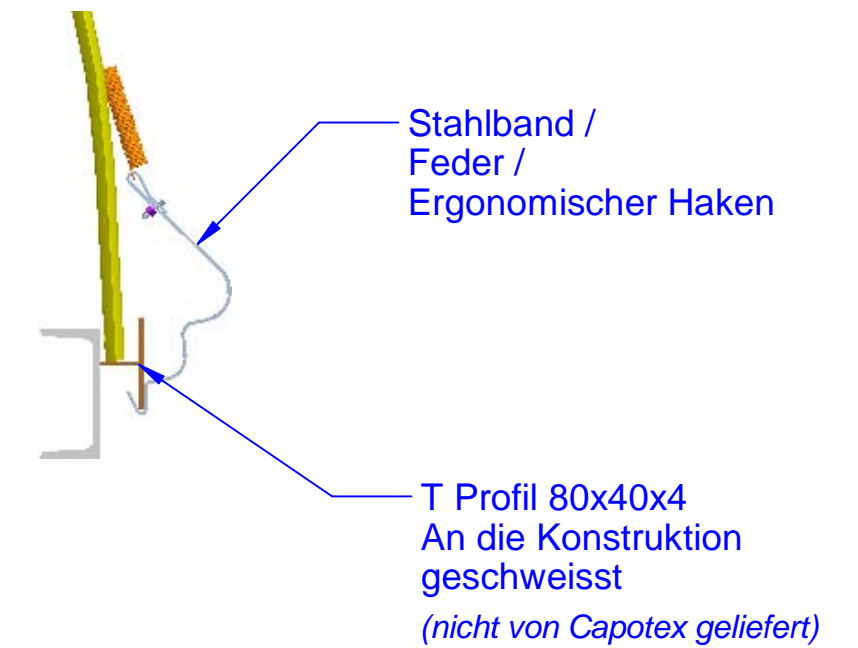
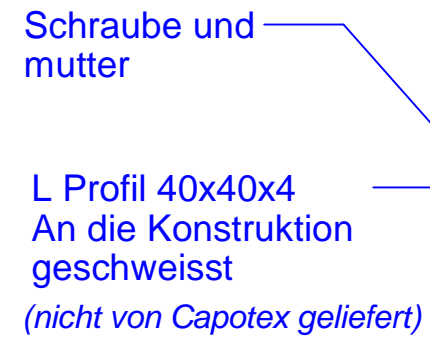

OPTION 5

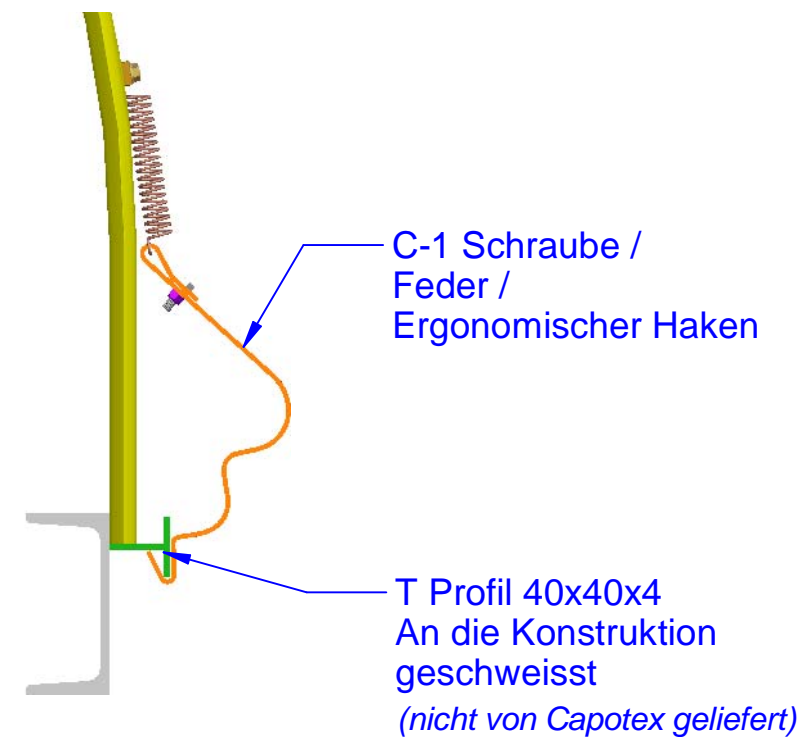
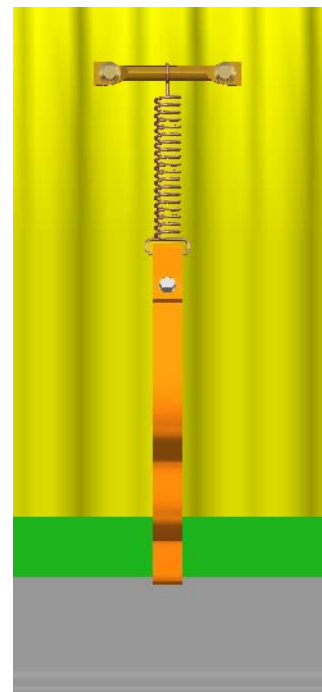

NOT SPECIFIED TOLERANCE

DIMENSIONS		ANGLES	
()	: ±2.00	0°	: ±02' 00"
X.	: ±0.50	0° 0'	: ±00' 30"
X.0	: ±0.25	0° 0' 0"	: ±00' 03"
X.00	: ±0.08		
X.000	: ±0.02		

CAD DRAWING. HANDLING ON CAD SYSTEM ONLY

THIS DRAWING IS OWNED BY **CAPOTEX**.
COPY OR REPRODUCTION IS FORBIDDEN
WITHOUT PREVIOUS NOTICE

SCALE

1:1

NAME

ABDECKUNG
MODELL DAKAR PLUS

DESIGNED

DRAWN

CHECKED

SHEET 6 OF 8 FORMAT

DATE

SIGNATURE

M. MATILLA

EUR A3

DRAWING NUMBER

CAD FILE

CAPOTAJE DAKAR PLUS REV.C.dft